BuzziNest Booth Product Specification Sheet

This document contains technical
information about the BuzziNest Booth



www.buzzi.space







Silent workspaces anywhere

BuzziNest Booth is all you need to erase distracting noise from any workplace. The compact acoustic privacy booth for one offers a private space to work and take calls in any open space without disturbing others, and most importantly, being disturbed. Due to its upholstered exterior and fabric panels on the interior, BuzziNest Booth effectively dampens sound from every direction to create maximum peace and quiet for everyone in the office, whether you are working inside BuzziNest Booth or out.

BuzziNest Booth is also customizable with high-quality materials and furniture. Choose from a wide range of fabrics, frames, door openings, shelf and table finishes, seating options, and table heights. The mobile BuzziNest Booth can easily fit into an existing space and comes fully packaged with a top-of-the-line motion sensor fresh air ventilation system, automatic LED lighting system, main power outlet (230V), and two USBs (A+C).

Design by BuzziSpace Studio

General

-  BuzziNest Booth
-  Structure: Laminated poplar plywood with visible trim
-  Cover: Inside: Felt, Felt Printed or 3D pattern in Fabric or Trevira CS+
Outside: Fabric covered foam with Fabric or Trevira CS+
-  Flat Packed
Installation time 1 to 1,5 hours, including unboxing
-  Optional Shelf with electrification
Milk Bar

Acoustics

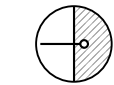

Absorption



Diffusion



Attenuation



Low Tone



Mid tone



High tone

Certifications





Content

Configurations	3	Finishes	9
Components	4	Dimensions	10
Fabrics	8	Acoustics	12

Configurations

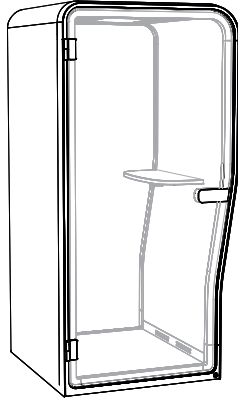
BuzziNest Booth



 BuzziNest Booth
Left or right handed

 Structure: Laminated poplar plywood with visible trim
Cover: Inside: Felt, Felt Printed or 3D pattern in Fabric or Trevira CS+
Outside: Fabric covered foam with Fabric or Trevira CS+

Power:

Mains supply: 230V, 50 Hz, max 10A

Stand-by consumption: 0,9W

Consumption when in use: 12,5W

 Internal fuses: 2 x 10A glass fuses (5 x 20mm, speed T)

Output:

Table socket – 230V, 50Hz, max 6A

Twin USB charger – type A and C, max 5A at 5VDC combined

Lighting unit:

Power usage: 14W

Input: 230V / 50Hz

Lumen output: 1260 lumen

Color Temperature: 4000K

Color Rendering Index: >80



Ventilation unit:

Power usage: 2,88W

Input: 12V dc

Airflow rate when occupied: 10l/s

Airflow rate after 5 mins no occupancy: 5l/s

Airflow rate stand-by mode, after 15 mins no occupancy: 2l/s



Installed

Length: 110 cm | 43.3"

Height: 218 cm | 85.8"

Width: 107 cm | 42.1"



Packaged (1 palletized crate)

Length: 222 cm | 87.4"

Height: 125 cm | 49.2"

Width: 79 cm | 31.1"



310 kg | 683 lbs

406 kg | 895 lbs



Optional Shelf with electrification
Milk Bar

Components

Outside

The outside shell is available in Fabric, Trevira CS+



Fabric



Trevira CS+

Inside

The inside cover is available in Felt, Felt Printed, Fabric* or Trevira CS+*
(*only in combination with 3D Rib)



Felt



Felt Printed



3D Rib Fabric/ Trevira CS+

Floor Cover

The floor cover is always in black carpet.



Frame

Frame is available in Laminated plywood White, Black or Truffle Grey



White



Black



Truffle Grey

Door Handle

Material: Oak with inlay in same color as frame



Shelf including electrification (optional)







Shelf in Oak or Laminated plywood White, Black or Truffle Grey

Mains power outlet and 2 USB chargers (type A and C) max 5A at 5VDC combined

When the BuzziNest is selected without shelf containing electrification, a Wieland connector is foreseen underneath the carpet to accommodate a 3rd party electrification unit.



Available for:

-  NL|DE|LUX
-  BE|FR
-  UK
-  AUS
-  CH
-  CN

Lighting

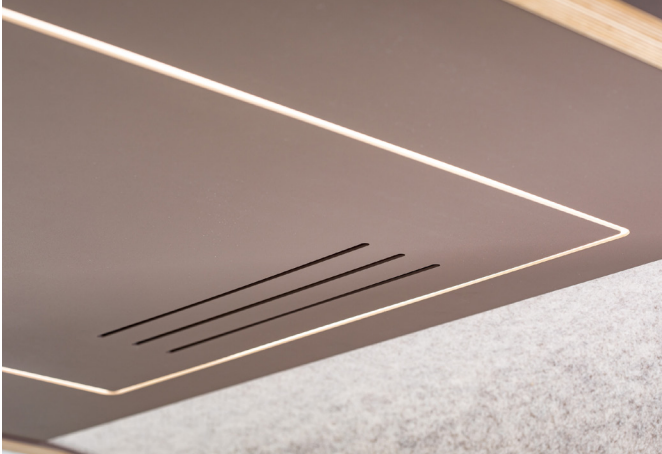

Integrated LED Light
Power usage: 14W
Input: 230V / 50Hz
Lumen output: 1260 lumen
Color Temperature: 4000K
Color Rendering Index: >80

Ventilation



For healthy air circulation there is a integrated ventilation. Cutout for sprinkler possible.
(please reach out to customer service for instructions)

Power usage: Max. 2,88W
Airflow rate:
- when occupied: 10l/s
- after 5 mins no occupancy: 5l/s
- stand-by mode, after 15 mins no occupancy: 2l/s

Power Connection

You can choose where to connect the power supply: at the side or on top.
Selecting the proper power inlet can be done by a switch situated behind the internal acoustic panels.



Wheels

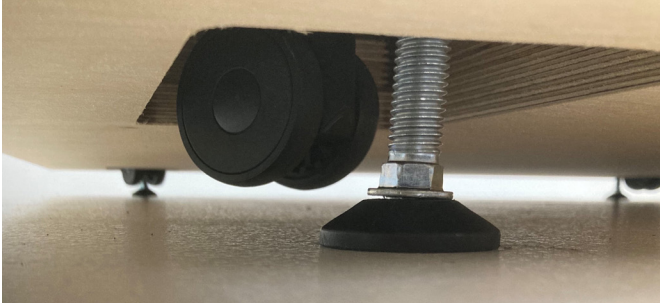

The BuzziNest Booth is moveable by the 4 wheels underneath. Floor adjusters are integrated for leveling.

Orientation



Left handed



Right handed

BuzziMilk Bar (optional)



The BuzziMilk Bar is the ideal stool to have in the BuzziNest Booth. More info [Buzzi.Space](https://www.buzzi.space)

Fabrics

Felt

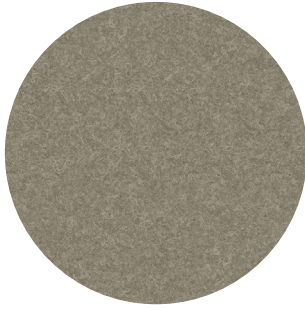

Composition 100% Recycled P.E.T. Felt, latex backing
Weight 1.000 g/m² | 29.49 oz/yd²
Abrasion resistance >7.000 Martindale
Flammability EU: EN 13501.1 + A1/2009 Class B-s1,d0
USA: ASTM E84 Class A certified
Fastness to light USA 5



Printed Felt



Composition 100% Recycled P.E.T. Felt, latex backing
Weight 1.000 g/m² | 29.49 oz/yd²
Abrasion resistance >7.000 Martindale
Flammability EU: EN 13501.1 + A1/2009 Class B-s1,d0
USA: ASTM E84 Class A certified
Fastness to light USA 5



Fabric

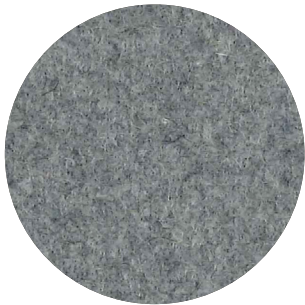

Category A
Composition 70% Recycled Wool, 25% Recycled Polyacryl,
5% Recycled Other Fabrics
Weight 405 g/m² | 11.94 oz/yd²
Abrasion resistance 40.000 Martindale, 50,000 Wyzenbeek
Flammability EU: EN 1021.1/2006 | BS EN 1021.1/2006 (cigarette).
EN 1021.2/2006 | BS EN 1021.2/2006 (match)
USA: CAL TB 117 | ASTM E84 CLASS A
Fastness to light EU: 4 | USA 4
Fastness to rubbing EU: Wet 3-4 | Dry 4-5
Fastness to crocking USA: Wet 5 | Dry 5



Trevira CS+ | CS

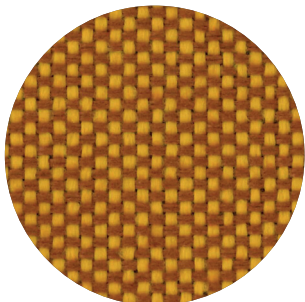

Category A
Weight 420 g/m² | 12.39 oz/yd²
Composition 100% Polyester, Trevira CS
Abrasion resistance 100.000 Martindale, 90,000 Wyzenbeek
Flammability BS 5852 part II: CRIB 5 | BS 7176 Medium Hazard
USA: CAL TB 117 | M1 | B1 | EN 1021/1-2 | C1 |
IMO Res. A652 (16)
Fastness to light EU: 6 | USA 5
Fastness to rubbing EU: Wet 4-5 | Dry 4-5
Fastness to crocking USA: Wet 5 | Dry 5



Finishes

Laminated Plywood with visible lining

Frame and shelf



White



Black

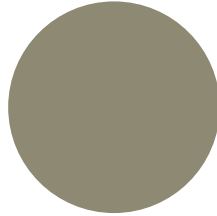

Truffle Grey



Plywood lining

Wood

Door handle and shelf



Oak

Dimensions

BuzziNest Booth

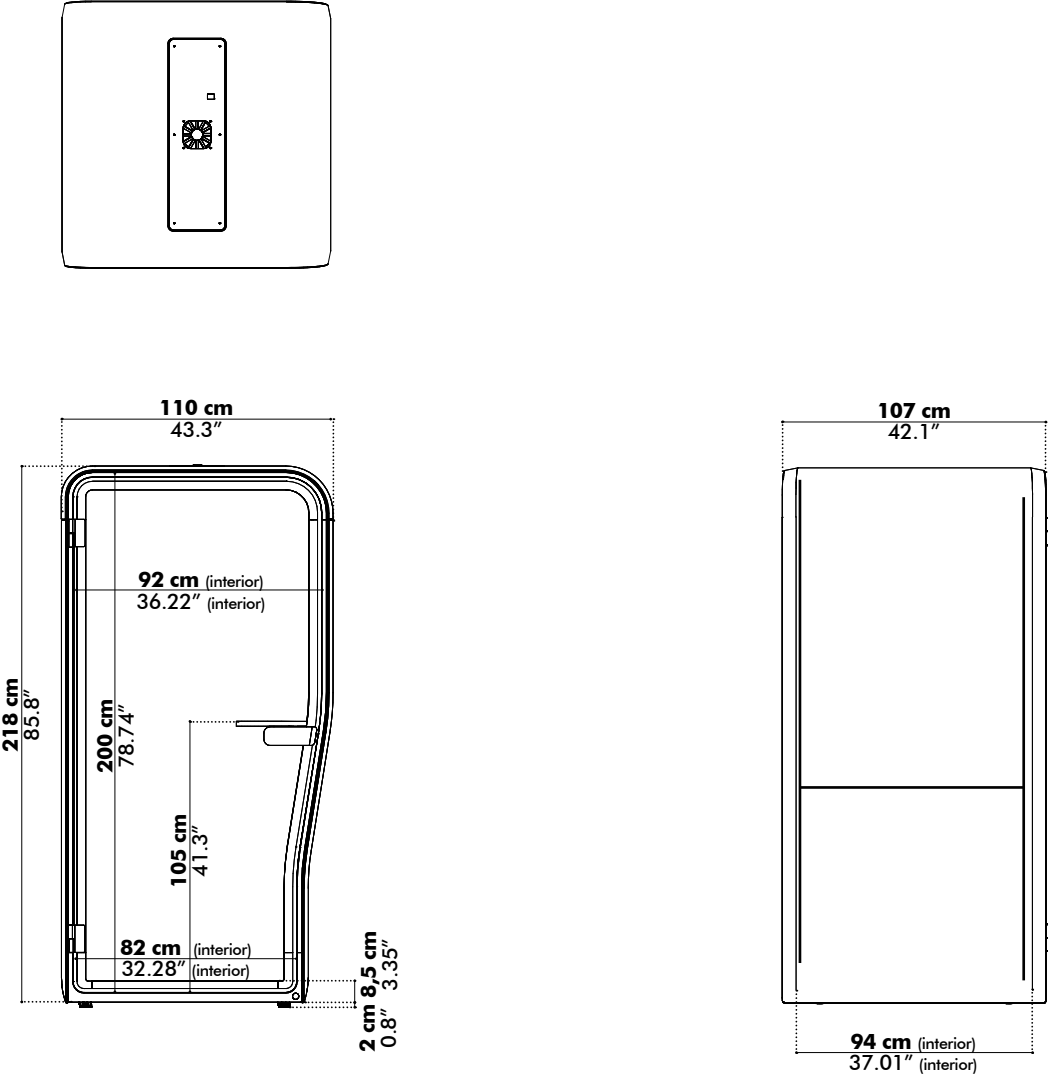

Shelf

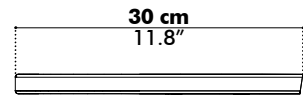
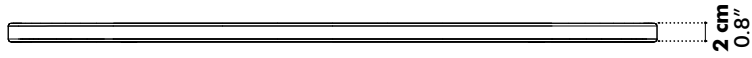
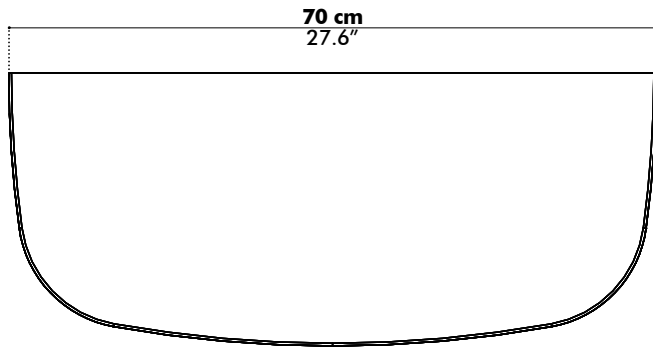

Acoustics

Sound blocker

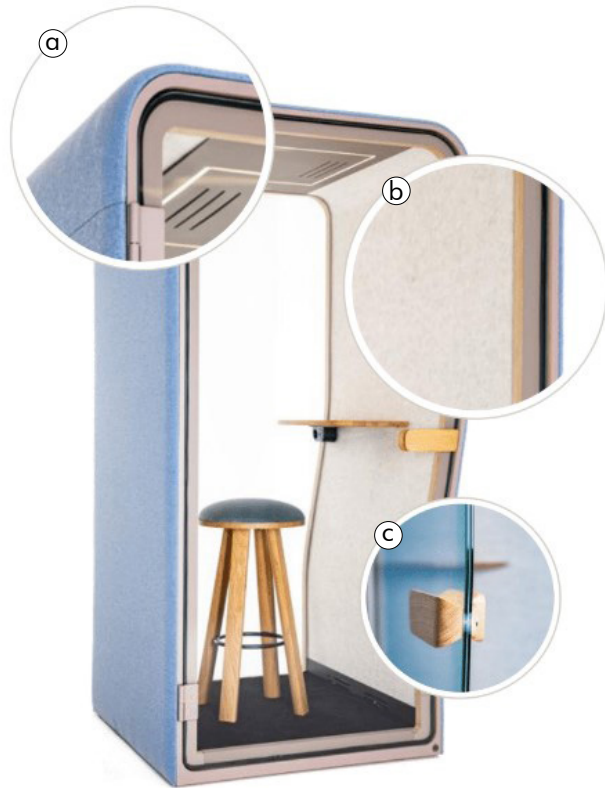

- a) Exterior: upholstered foam
- b) Interior: acoustic Felt or 3D Rib foam pattern
- c) Glass with acoustic foil

Peace and quiet inside

27dB sound reduction, a conversation is turned into an indistinguishable whisper.

Acoustic Principles



Max. absorption on the outside



Max. attenuation on the inside

High performer on all frequencies, especially speech frequencies



Low tones



Mid tones



High tones

Speech Level Reduction*

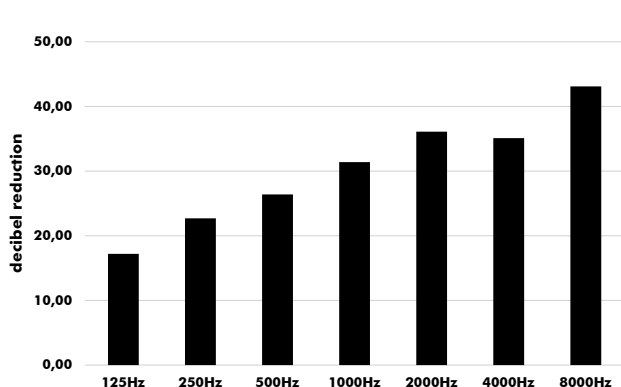

Hz	dB
125	17.2
250	22.7
500	26.4
1000	31.4
2000	36.1
4000	35.1
8000	43.1

Rating According to ISO 23351-1:2020
Speech Level Reduction, $D_{S,A} = 27.1$ dB

Equivalent sound absorption area in m² per object*

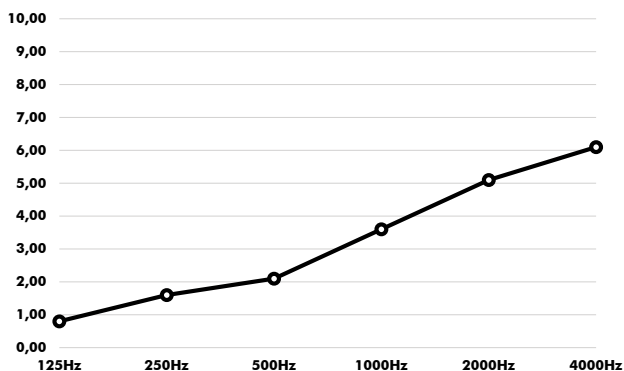

Hz	Aeq/m ²
125	0.8
250	1.6
500	2.1
1000	3.6
2000	5.1
4000	6.1

*Full test report available on our website